

VRT 230

VRT 240

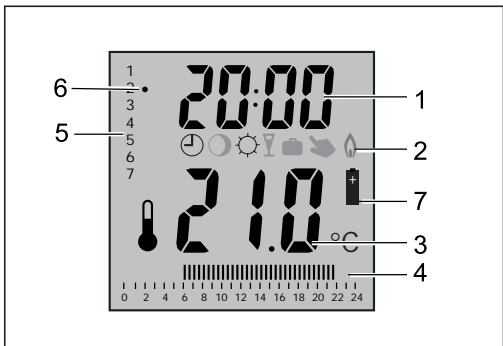

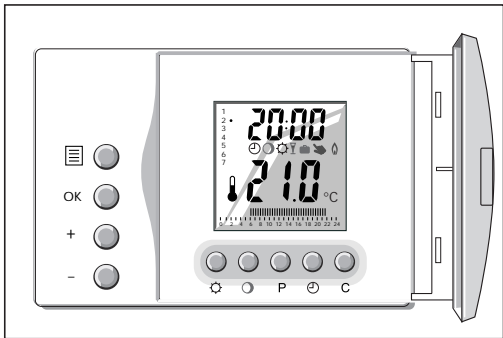



DE	Bedienung	4
	Montage	7
GB	Operating	9
	Montage	12
FR	Notice d'utilisation	14
	Notice de montage	17
ES	Instrucciones de Uso	19
	Montaje	22
IT	Uso	24
	Installazione	27
NL	Bediening	29
	Montage	32
DK	Betjening	34
	Montage	37
PL	Obsługa	39
	Montaż	42
HU	Kezelés	44
	Szerelés	47
CZ	Návod k obsluze	49
	Návod k montáži	52
RO	Exploatare	54
	Instalare	57
HR	Rukovanje	59
	Montaža	62
SK	Obsluha	64
	Montáž	67
TR	Kullanım kılavuzu	69
	Montaj kılavuzu	72
RUS	Эксплуатация	74
	Монтаж	77









Bedienung

Lassen Sie in dem Zimmer, indem sich Ihr Raumtemperaturregler befindet, stets alle Heizkörperventile voll geöffnet.

Bedienelemente

-  Betriebsart wählen
- OK Wert bestätigen, weiterblättern
- + Wert erhöhen
- Wert verringern
-  Tagtemperatur einstellen/wählen
-  Absenkttemperatur einstellen/wählen
- P Heizzeiten programmieren
-  Uhrzeit und Wochentag einstellen
- C Wert rücksetzen/Zurück springen

Display Übersicht

- 1 Aktuelle Uhrzeit
- 2 Symbole
 -  Die Raumtemperatur wird vom eingegebenen Programm geregelt.
 -   - Absenktzeit
 -   - Heizzeit
 -  Ständige Regelung der Raumtemperatur entsprechend der Absenkttemperatur.
 -  Ständige Regelung der Raumtemperatur entsprechend der Tagtemperatur.

▼ Partyfunktion: Bis zum Beginn der nächsten Heizzeit wird die Raumtemperatur entsprechend der Tagtemperatur geregelt.

☑ Ferienprogramm: Für die Dauer Ihres Urlaubs wird die Raumtemperatur entsprechend der eingestellten Temperatur geregelt.

➡ Kurzfristige Temperaturveränderung

🔥 Wärmeforderung an das Heizgerät

3 Aktuelle Temperatur

4 Balkenanzeige (I = Heizzeit ein)

5 Wochentage

(1 = Mo, 2 = Di, 3 = Mi, 4 = Do, 5 = Fr, 6 = Sa, 7 = So)

6 Markierung des aktuellen Wochentags

7 **Batterie nur bei VRT 240**

(blinkend = Batterie wechseln, Restlaufzeit ca. 4 Wochen)



Gefahr der Überhitzung des Raumes! Bei erschöpfter Batterie arbeitet das Heizgerät mit max. Vorlauftemperatur (Frostschutz).

Beschreibung des Gerätes

Der VRT 230/240 ist ein Raumtemperaturregler mit Wochen-Heizprogramm.

Er verfügt über 2 Grundprogramme P1 und P2, ein veränderbares Blockprogramm P3 und ein individuell einstellbares Programm Pi.

Einstellung der Programme		Werksseitig
	Heizzeiten	
P1	6:00-22:00 Uhr	Mo-Fr
P2	7:30-22:30 Uhr	Sa
P3	einstellbar (für mehrere Tage wählbar) 7:30-22:30 Uhr	So
Pi	einstellbar (für jeden Tag individuell)	

Seite

Betriebsart wählen	80
Urlaubsfunks aktivieren	82
Temperatur kurzfristig verstellen	84
Tagtemperatur eistellen	86
Absenkttemperatur einstellen	86
Uhrzeit und Wochentag einstellen	88
Grundprogramm auswählen	90
Programm P3 und Pi einstellen	92
Batterie ersetzen	94
Schalten über Telefonfernkontakt	96

Montage

Installation des Reglers

Dieses Gerät darf nur von einem anerkannten Fachmann geöffnet und gemäß den Abbildungen der Seiten 98 bis 101 installiert werden. Dabei sind die bestehenden Sicherheitsvorschriften zu beachten.



Lebensgefahr durch Stromschlag an spannungsführenden Anschlüssen. Vor Arbeiten am Gerät die Stromzufuhr abschalten und vor Wiedereinschalten sichern.

Für Schäden, die durch Nichtbeachtung dieser Anleitung, insbesondere durch Fehlverdrahtung oder mechanische Beschädigung entstehen, übernehmen wir keine Haftung.

Telefonfernswitcher (TEL) anschließen

Der Schaltausgang des Telefonfernswitchers wird an der Klemme TEL des Reglers angeschlossen (siehe Abbildungen Seiten 100 und 101).





Bitte beachten Sie die Installationsanleitung des Telefonfernswitchers.

Gerätebezeichnung	VRT 230	VRT 240
Betriebsspannung	230 V~	2x1,5 V (AAA-LR03)
Stromaufnahme	< 3 mA	< 40 μ A
Lebensdauer Batterie - Alkaline)		ca. 1,5 Jahre
Gangreserve Uhr	0,5 h	0,5 h
max. Kontaktbelastung	5 A/250 V~ $\cos \varphi=1$	
Tagtemperaturbereich	5 ... 30°C	
Absenkttemperaturbereich	5 ... 20°C	
Schaltdifferenz	≤ 1 K	
Anschlussleitungen	3x0,75 mm ²	2x0,75mm ²
Schutzart	IP 30	IP 30
Schutzklasse	II	III
Betriebstemperatur	+ 5 ... + 50 °C	
Zul. Lagertemperatur	- 20 ... + 65 °C	
Abmessungen	111 x 81 x 33 mm	
Eingang TEL aktiv	230 V~	







Utilisation

Laissez toujours tous les robinets des radiateurs complètement ouverts dans la pièce où se trouve votre thermostat d'ambiance.

Organes de commande

-  Sélectionner le mode de fonctionnement
- OK Confirmer la valeur, avancer dans le programme
- + Augmenter la valeur
- Réduire la valeur
-  Régler/Choisir la température jour
-  Régler/Choisir la température nocturne
- P Programmer les heures de chauffage
-  Régler les heures et jours de semaine
- C Revenir en arrière/Restituer la valeur

Vue d'ensemble de l'écran

- 1 Heure actuelle
- 2 Symboles
 -  La température ambiante est régulée par le programme sélectionné.
 -   - Période d'abaissement
 -   - Période de chauffe
 -  Régulation permanente de la température ambiante en fonction de la température d'abaissement.
 -  Régulation permanente de la température ambiante en fonction de la température jour

- ▼ Fonction party : la température ambiante est réglée en fonction de la température jour jusqu'à la prochaine période d'abaissement.
- 📅 Programme congés : la température ambiante est réglée en fonction de la température demandée pour la durée de vos vacances.
- ➡ Brève modification de température
- 🔥 Demande chauffage à l'appareil
- 3 Temperature actuelle

- 4 Affichage barres (1 = Période de chauffe)e)
- 5 Jour de la semaine (1 = lu, 2 = ma, 3 = me, 4 = je, 5 = ve, 6 = sa, 7 = di)
- 6 Marquage du jour en cours de la semaine
- 7 **Piles: Seulement pour les VRT 240** (clignotement = piles à changer, temps de fonctionnement restant: 4 semaines)



Danger de surchauffe de la pièce: en cas de pile usée, la chaudière fonctionne avec une température de maximale de départ (pour éviter le gel).

Description de l'appareil

Les VRT 230 et VRT 240 sont des thermostats d'ambiance avec programmation hebdomadaire du chauffage.

Ils disposent de 2 programmes de base P1 et P2, d'un programme bloc modifiable P3 et d'un programme individuel réglable Pi.

Réglage des programmes périodes de chauffe		Réglés d'usine
P1	6:00-22:00 heures	du lu au ve
P2	7:30-22:30 heures	sa
P3	réglable (pour plusieurs jours au choix)	di
Pi	réglable (pour chaque jour individuellement)	

page

Choix du mode de fonctionnement	80
Activer la fonction congés	82
Brève modification de la température	84
Réglage de la température jour	86
Réglage de la température d'abaissement	86
Réglage jour et heure	88
Choix du programme de base	90
Réglage des programmes P3 et Pi	92
Remplacement piles	94
Enclenchement par téléphone	96

Montage

Installation du thermostat d'ambiance

Cet appareil ne peut être ouvert et installé que par un professionnel qualifié conformément aux schémas des pages 98 à 101. Il convient, à cet effet de respecter les consignes de sécurité existantes.



Danger d'électrocution sur les raccordements conducteurs de courant. Avant les travaux sur l'appareil, couper l'alimentation secteur et mettre des coupe-circuits avant la remise en marche.

Nous ne sommes pas responsables des dommages pouvant découler du non-respect de ce mode d'emploi, des câblages défectueux ou détériorations mécaniques.

Raccordement du commutateur téléphonique à distance

Le commutateur est raccordé sur les bornes TEL de la régulation (voir schéma pages 100 et 101)





Merci de suivre la notice d'installation du commutateur téléphonique.

Type d'appareil	VRT 230	VRT 240
Tension de fonctionnement	230 V~	2x1,5 V (AAA-LR03)
Puissance absorbée	< 5mA	< 400μA
Durabilité des piles (env.)		1,5 années
(Piles Alkaline) Réserve de marche	0,5 h	0,5 h
Densité max. du charge	5 A/250 V~ cos φ=1	
Plage de température jour	5 ... 30°C	
Plage de température d'abaissement	5 ... 20°C	
Plage proportionnelle	≤ 1K	
Câbles de raccordement	3x0,75 mm ²	2x0,75mm ²
Type de protection	IP 30	IP 30
Classe de protection	II	III
Temp. de fonctionnement	+ 5 ... + 50 °C	
Temp. stockage admise	- 20 ... + 65 °C	
Dimensions	111 x 81 x 33 mm	
Entrée bornes TEL activée	230 V~	







Bediening

Zorg er voor dat in de ruimte waar de klokthermostaat is gemonteerd altijd de radiatorkranen volledig zijn geopend.

Bedieningselementen

-  Bedrijfsfunctie kiezen
- OK Waarde bevestigen, doorbladeren
- + Waarde verhogen
- Waarde verlagen
-  Dagtemperatuur instellen/kiezen
-  Verlagingstemperatuur instellen/kiezen
- P Verwarmingsperioden programmeren
-  Tijd en dag instellen
- C Terugstappen/waarde corrigeren

Displayoverzicht

- 1 1 Actuele tijd
- 2 Symbolen
 -  Automatisch volgens geprogrammeerde perioden
 -   - Verlagingsperiode
 -   - Verwarmingsperiode
 -  Constante regeling volgens de ingestelde verlagingstemperatuur.
 -  Constante regeling volgens de ingestelde dagtemperatuur.

- ▽ Partyfunctie: tot de eerstvolgende verlagingperiode wordt de temperatuur volgens de ingestelde dagtemperatuur geregeld.
 - 🗑️ Vakantieprogramma: gedurende uw vakantie wordt de kamertemperatuur volgens de ingestelde temperatuur geregeld.
 - ➡️ Kortstondige temperatuurwijziging
 - 🔥 Warmtevraag aan het CV-toestel
- 3 Actuele kamertemperatuur
 - 4 Balkenaanwijzing (I = verwarming aan)
 - 5 Dag van de week (1 = ma, 2 = di, 3 = wo, 4 = do, 5 = vr, 6 = za, 7 = zo)
 - 6 Markering van de actuele dag van de week
 - 7 **Batterij, alleen bij VRT 240** (knippert = batterij vervangen, resterende looptijd is ca. 4 weken)



LET OP! Gevaar voor oververhitting van de woning. Bij totaal uitgeputte batterijen wordt het verwarmingstoestel ingeschakeld (vorstbeveiliging).

Productomschrijving

De VRT 230 en de VRT 240 zijn aan/uit thermostaten met een zeven dagen programmeerbare schakelklok voor de besturing van een CV-toestel.

De regelaars beschikken over twee vast ingestelde basisprogramma's P1 en P2, een aan te passen blokprogramma P3 en een individueel instelbaar programma Pi.

	Geprogrammeerde verwarmingsperioden	Dagen van de week
P1	6:00-22:00 uur	Ma - Vrij
P2	7:30-22:30 uur	Za
P3	Instelbaar (voor meerdere dagen toepasbaar)	Zo
Pi	Instelbaar (voor elke dag individueel)	

Bediening**Pagina**

Bedrijfsfunctie kiezen	80
Vakantieprogramma activeren	82
Kamertemperatuur kortstondig wijzigen	84
Dagtemperatuur instellen	86
Verlagingstemperatuur instellen	86
Tijd en dag van de week instellen	88
Basisprogramma's kiezen	90
Programma's P3 en Pi instellen	92
Batterij vervangen	94
Inschakelen op afstand via de telefoon	96

Montage van de regelaar en de ontvanger

Dit product mag alleen door een deskundige installateur worden geopend en volgens de afbeeldingen van pagina 98 tot 101 worden gemonteerd.

Hiervoor moeten de bestaande veiligheidsvoorschriften in acht worden genomen.



Levensgevaar door elektrocutie van onder spanning staande delen.

Bij werkzaamheden aan het toestel altijd de stroomtoevoer afsluiten en beveiligen tegen ongeoorloofd/per ongeluk weer inschakelen.

Voor schade die voortvloeit uit het niet opvolgen van de aanwijzingen uit deze handleiding en in het bijzonder schade ontstaan door het fout aansluiten van de bedrading of mechanische beschadiging zijn wij niet aansprakelijk.

Telefoonafstandsbediening aansluiten (n.v.t. in NL)

De schakeluitgang van de telefoon afstandbediening wordt aangesloten aan de klemmen 5 en TEL van de regelaar (zie afbeelding pagina 100/101).

Technische gegevens

Productbenaming	VRT 230	VRT 240
Bedrijfsspanning regelaar	230 V~	2x1,5 V (AAA-LR03)
Opgenomen vermogen	< 5mA	< 400 μ A
Batterij levensduur		1,5 jaar
Gangreserve	0,5 h	0,5 h
Max. contactbelasting	5 A/250 V~ $\cos \varphi=1$	
Instelbereik dagtemperatuur	5 ... 30°C	
Instelbereik verlagingstemperatuur	5 ... 20°C	
Schakelverschil	$\leq 1K$	
Doorsnede van de aansluitleidingen	3x0,75 mm ² IP 30	2x0,75mm ² IP 30
Beschermingsklasse	II	III
Bedrijfstemperatuur	+ 5 ... + 50 °C	
Max. toelaatbare opslagtemperatuur	- 20 ... + 65 °C	
Afmetingen (lxbxd)	111 x 81 x 33 mm	
Telefooningang actief	230 V~	

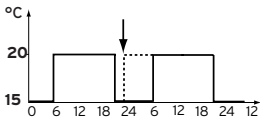
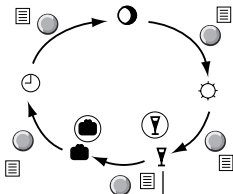
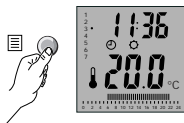

DE	Betriebsart wählen
GB	Choose the operating mode
FR	Choix du mode de fonctionnement
ES	Seleccionar modo de funcionamiento
IT	Impostazione del modo operativo
NL	Bedrijfsfunctie kiezen
DK	Valg af driftsart
PL	Wybór trybu pracy
HU	Üzem mód kiválasztása
CZ	Volba druhu provozu
RO	Selectarea regimului de funcționare
HR	Odabirati način rada
SK	Voľba prevádzkového režimu
TR	İşletme türü seçimi
RUS	Выбор режима работы

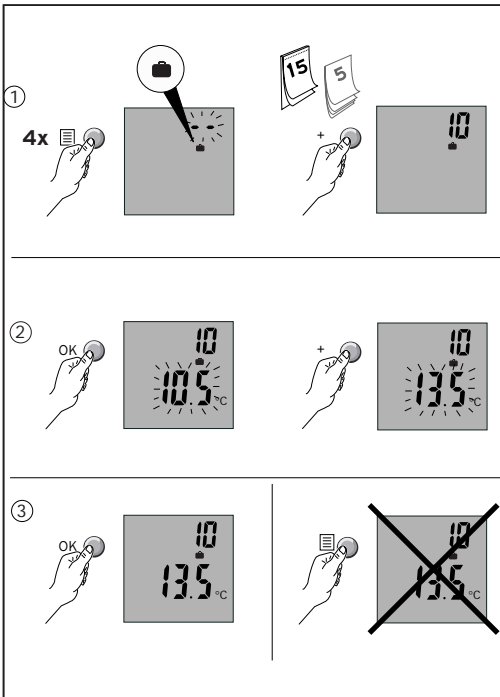

DE	Urlaubsfunktion aktivieren
GB	Activate the holiday program
FR	Activer la fonction congés
ES	Activar funcionamiento en vacaciones
IT	Impostazione programma vacanze
NL	Vakantieprogramma activeren
DK	Aktivering af feriedrift
PL	Aktywacja funkcji urlopowej
HU	Szabadság-funkciók aktiválása
CZ	Aktivace funkce "dovolená"
RO	Activarea funcției concediu
HR	Aktivirati funkciju godišnjeg odmora
SK	Aktivácia dovolenkovej funkcie
TR	Tatil foksiyonunu çalıştırma
RUS	Включение программы "Отпуск"

①



②a

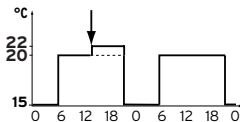

②b

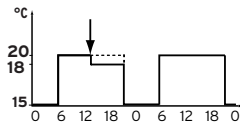

③

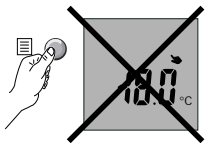

DE	Temperatur kurzfristig verstellen
GB	Temporary change of temperature setting
FR	Brève modification de la température
ES	Variar temperatura a corto plazo
IT	Modifica temporanea temp. ambiente
NL	Kamertemperatuur kortstondig wijzigen
DK	Midlertidig ændring af temperatur
PL	Krótkotrwałe przestawienie temperatury
HU	Hőmérséklet módosítása rövid időre
CZ	Krátkodobá změna teploty
RO	Scurtă modificare a temperaturii
HR	Kratkotrajno promijeniti temperaturu
SK	Krátkodobé prestavenie teploty
TR	Kısa bir süre için sıcaklık değiştirilmesi
RUS	Кратковременная перестановка температуры

☀ °C



○ °C



DE	Tag-/Absenkttemperatur einstellen
GB	Adjust the day / night temperature
FR	Réglage température jour / d'abaissement
ES	Ajustar temperatura diurna / descenso de temperatura
IT	Impostazione della temperatura diurna/attenuata
NL	Dagtemperatuur / Verlagingstemperatuur instellen
DK	Indstilling af dagtemperatur/nattemperatur
PL	Ustawienie temperatury dziennej/obniżonej
HU	Nappali hőmérséklet beállítása "Csökkentett hőmérséklet" beállítása
CZ	Nastavení denní / snížené teploty
RO	Reglarea temperaturii de zi / de noapte
HR	Podesiti dnevnu / sniženu temperaturu
SK	Nastavenie dennej / zníženej teploty
TR	Gündüz sıcaklığının ayarlanması Gece sıcaklığının ayarlanması
RUS	Установка дневной / ночной температуры помещения

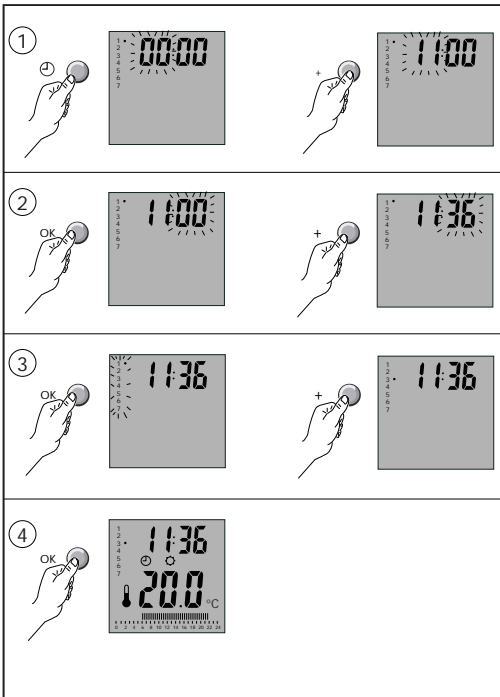

DE	Uhrzeit und Wochentag einstellen
GB	Set the date and time
FR	Réglage heure et jour
ES	Ajustar el tiempo horario y el día de la semana
IT	Impostazione ora e giorno della settimana
NL	Tijd en dag van de week instellen
DK	Indstilling af klokkeslæt og ugedag
PL	Ustawienie godziny i dnia tygodnia
HU	A pontos idő és hét napjának beállítása
CZ	Nastavení denního času a dne v týdnu
RO	Reglarea orei și a zilei săptămânii
HR	Podesiti vrijeme i dan u tjednu
SK	Nastavenie dňa v týždni a času
TR	Saatın ve haftanın gününün ayarlanması
RUS	Установка времени и дня недели

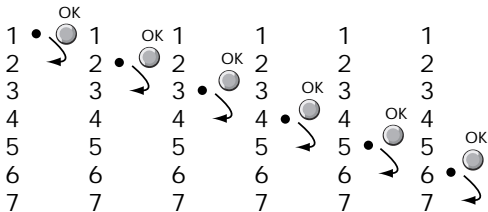
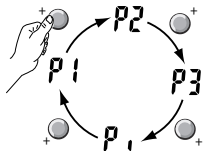
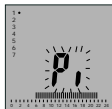

DE	Programm auswählen
GB	Choose a program
FR	Choix du programme
ES	Seleccionar programa
IT	Scelta del programma
NL	Programma's kiezen
DK	Valg af program
PL	Wybór programu podstawowego
HU	Program kiválasztása
CZ	Výběr základního programu
RO	Selectarea programului de bază
HR	Odabrati program
SK	Výber základného programu
TR	Programın seçilmesi
RUS	Выбор программы

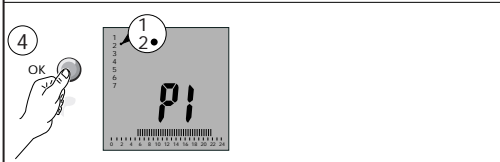
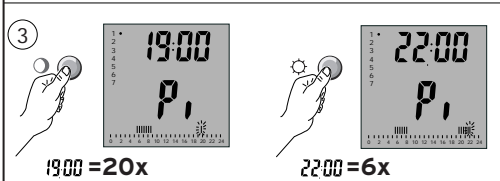
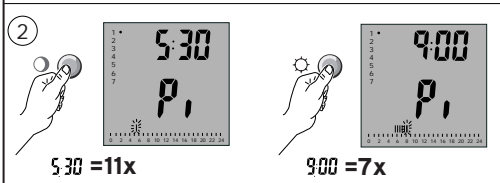
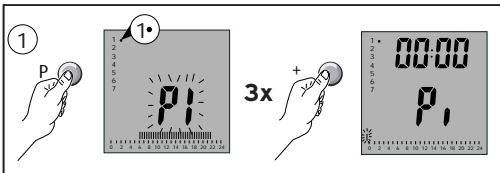

DE	Programm P3 und Pi einstellen
GB	Set program P3 or Pi
FR	Réglage Programmes P3 et Pi
ES	Ajustar programa P3 y Pi
IT	Impostazione dei programmi P3 e Pi
NL	Programma's P3 en Pi instellen
DK	Indstilling af program P3 og Pi
PL	Ustawienie programów P3 i Pi
HU	P3 és Pi program beállítása
CZ	Nastavení programu P3 a Pi
RO	Modificarea programelor P3 și Pi
HR	Podesiti program P3 i Pi
SK	Nastavenie programu P3 a Pi
TR	P3 ve Pi programlarının ayarlanması
RUS	Задание программ P1 и Pi

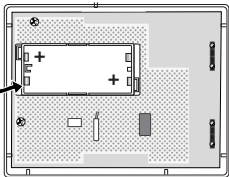
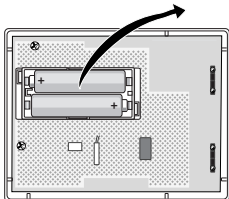
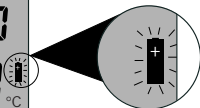

2 x AAA
LR03



DE	VRT 240 Batterie ersetzen
GB	VRT 240 Change batteries
FR	VRT 240 Remplacement piles
ES	VRT 240 Cambiar baterías
IT	VRT 240 Sostituzione delle batterie
NL	VRT 240 Batterij vervangen
DK	VRT 240 Batteriskifte
PL	VRT 240 Wymiana baterii
HU	VRT 240 Elemcsere
CZ	VRT 240 Výměna baterie
RO	VRT 240 Schimbarea bateriei
HR	VRT 240 Zamijeniti bateriju
SK	VRT 240 Výmena batérií
TR	VRT 240 Pil deđiřimi
RUS	VRT 240 Замена элементов питания

1



2

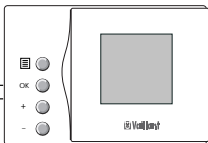

3



DE	Schalten über Telefonkontakt
GB	Connect with remote-control switch (not currently available in the UK)
FR	Enclenchement par téléphone
ES	Conectar por contacto telefónico
IT	Inserire il comando telefonico a distanza
NL	Inschakelen op afstand via de telefoon
DK	Styring via telefon
PL	Przełączenie przez telefon
HU	Telefoni átkapcsolás
CZ	Spínání pomocí telefonního kontaktu
RO	Cuplarea prin intermediul telefonului
HR	Upravljanje preko daljinske telefonske sklopke
SK	Zapnutie prostredníctvom telefonického kontaktu
TR	Telefon bađlantısı ile kumanda
RUS	Управление через телефонный контактор

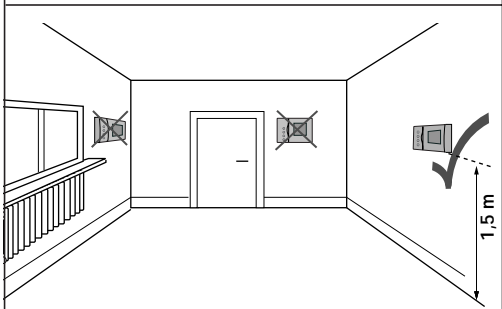
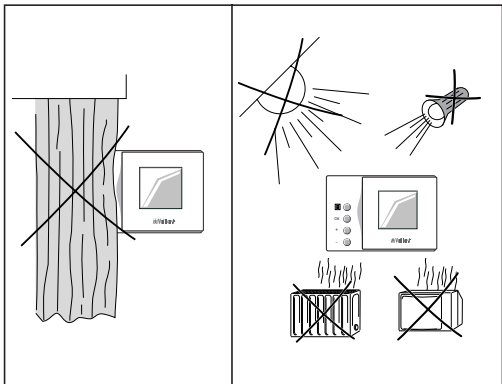

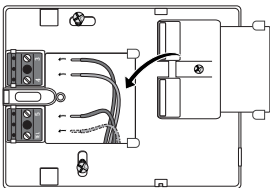
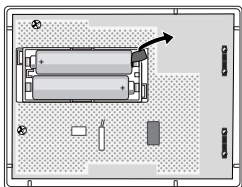
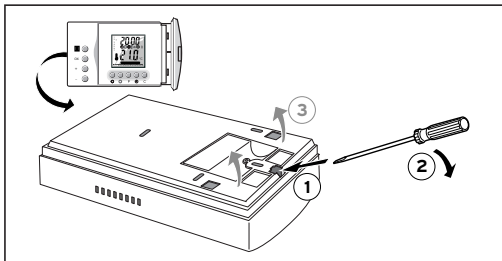

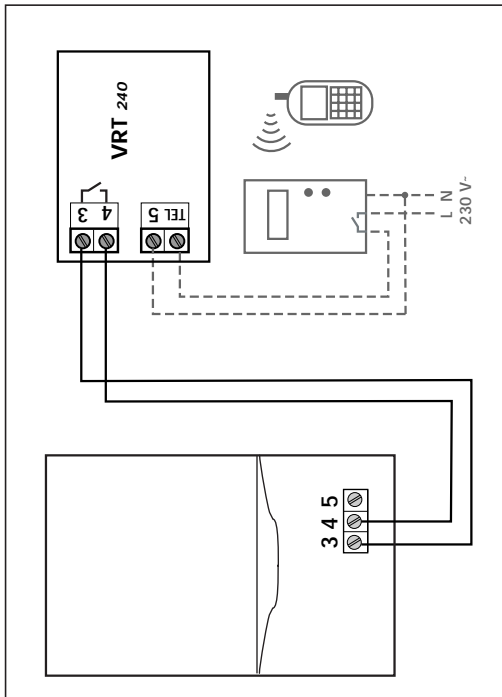

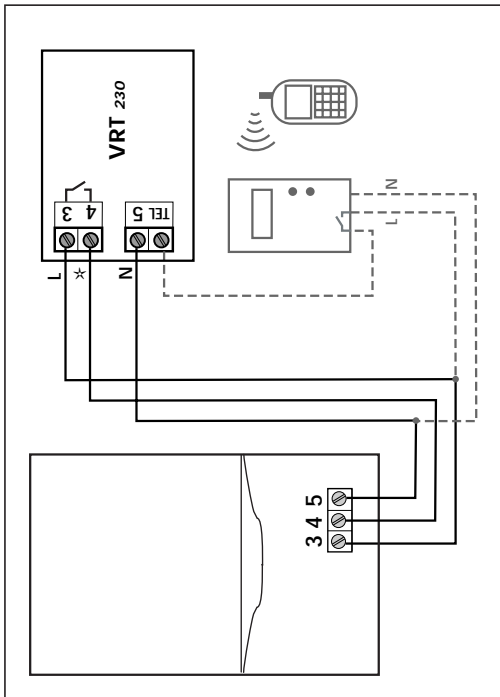

Vaillant GmbH

Berghauser Str. 40 ■ 42859 Remscheid ■ Telefon 0 21 91/ 18-0
Telefax 0 21 91/ 18-28 10 ■ www.vaillant.de ■ info@vaillant.de

83 46 78 INT01 01/02 V Änderungen vorbehalten